



GRASS MOVEMENT SYSTEMS

GRASS PRO1

Operating Manual

 **GRASS**[®]

Table of Content

GRASS PRO1	
OWNER REGISTRATION FORM.....	III
1.0 Introduction	2
1.1 Instructions for Installers.....	2
1.2 Symbols in this Manual.....	2
1.3 Intended Use.....	2
2.0 Technical Data	3
3.0 Manufacturer.....	4
3.1 Copyright.....	4
4.0 Warranty conditions.....	4
5.0 Safety Instructions.....	5
5.1 Residual Risks in Accordance with EN ISO 10200-1	5
5.2 Hazards and Safety Measures.....	6
5.3 Safety Equipment	7
5.4 Machine Warning Labels.....	7
5.5 Purpose	7
5.6 Identification of the Product	7
6.0 Standard Specification.....	8
7.0 Location of Main Components	9
8.0 Gearbox hole patterns GRASS PRO1.....	10
9.0 Description of the operating elements	10
10.0 Circuit diagrams.....	11
10.1 Pneumatic Circuit Diagram	11
10.2 Electrical Circuit Diagram	12
11.0 Transport, installation, and final adjustment.....	13
11.1 Scope of Supply	13
11.2 Transport and Storage Conditions.....	13
11.3 Space Requirements and Surrounding Conditions.....	13
12.0 Commissioning.....	14
12.1 Pneumatic Connection	14
12.2 Removal of the Drop Arrester	14
12.3 Function Test	15
13.0 Working with the GRASS PRO1	16
13.1 Requirements for the Operating Personnel.....	16
14.0 Set-up of the GRASS PRO1 for Hinges	16
14.1 Installing an Insertion Die (ID).....	16
14.2 Setting the Drilling Depth using the bits.	17
14.3 Setting the drilling depth	17
14.4 Setup for cup-hole location.....	18
14.5 Adjustment of the Side Stops	19
14.6 Adjustment of the Hold-down Devices	19
15.0 Operation of GRASS PRO1 for Drawer Assembly	20
15.1 Assembly of Zargen & ZBox with PRO1	20
16.0 PRO1 Machine Options and Accessories.....	21
16.1 for Hinge Drilling	21
16.2 For Drawer Assembly	22
16.3 For Vionaro Assembly.....	23

1.0 Introduction



Please read this operating manual carefully and act accordingly.
Keep this operating manual for future reference or for a subsequent owner.

1.1 Instructions for Installers

The following installation and operating instructions contain important tips, instructions and recommendations for installation, commissioning and operation. In order to ensure safe and flawless operation of the GRASS PRO1, please read and adhere to these instructions.

1.2 Symbols in this Manual

The signs and symbols in this operating manual are intended to ensure quick and safe use of the manual and the system.



Warning of a general danger

This warning sign indicates actions which may for several reasons cause danger, impair machine functionality, or provide important information for machine function.



Warning of hazardous voltage

This warning sign indicates actions during which you will be exposed to danger due to electric shock possibly causing fatal injuries.

1.3 Intended Use

The Grass PRO1 is intended exclusively for drilling in solid wood and wood materials. Use for any other purpose is not considered an intended use. The manufacturer assumes no liability for any damage or injury resulting from such use. This risk must be borne solely by the machine owner. The intended use also implies observance of the operating manual. The machine may only be operated, maintained and repaired by trained and authorized persons. The original equipment must not be changed without the approval of Grass GmbH.

2.0 Technical Data

Dimensions	
Machine table width	600mm
Machine table height	100mm
Machine table depth	400mm
Overall machine height	800mm
Overall machine depth	710mm
Adjustment Ranges of the Machine	
Drill bit length - maximum possible length	57.5mm
Drill bit diameter - maximum permissible bit diameter at the cup spindle	35mm
Drill bit diameter - maximum permissible bit diameter on all other spindles	10mm
Other Data	
Insertion force at 0.6 MPa (6 bar)	approx. 3200 N
Weights	
Total weight of the GRASS PRO1 standard specification	125 lbs. /70 kg
Electrical Connections	
Motor NOTE: READ motor plate because each motor will vary.	220/1 phase; 60Hz; 1.8 kw; 12.4 amp; 3250 rpm 220/3 phase; 60Hz; 1.1 kw; 6.4 amp; 3370 rpm 110/1 phase; 60Hz; 20.5 amp, 3240 rpm
Power feeder size in accordance with the local regulations, but at least 1.5mm.	
Fuse in the power feeder with max. 1.5 x rated current according to rating plate, but max. 12 A.	
Pneumatic Connections	
Air connection	8mm
Dust, water, and oil-free compressed air	min. 6 bar
Max. admissible pressure in supply line	8 bar
Compressed air consumption per drilling stroke at 6 bar	1.8 l
Compressor/ tank capacity	min. 100 liters
Intake capacity	200 liters/min
Other Dimensions	
Cylinder diameter	80mm
Stroke height	140mm
Emission Values	
Noise emissions (vary depending on material)	82 dBA

3.0 Manufacturer

GRASS GmbH & Co. KG

www.grass.at

3.1 Copyright

The copyright to this documentation lies exclusively with the manufacturer. Any form of duplication, in whole or in part, is only permitted with the approval of the manufacturer unless the duplicated manual is necessary for operation of the GRASS PRO1.

4.0 Warranty conditions

The GRASS PRO1 has been produced from the best material and by highly qualified staff. Continuous quality controls and test runs of each individual product ensure that the machine is delivered in a flawless and functional condition. For this reason we assume a warranty of 12 months starting from the date of delivery. Should a fault nevertheless occur in the machine, please contact your responsible dealer, presenting the invoice or delivery note.

The warranty covers purely the replacement of parts, not the necessary labor times, waiting times, consequential damage, etc.

The warranty does not cover:

- Transport damage (please report this immediately to the responsible shipping agent)
- Damaged caused by improper use
- Compensation for standstill times
- Normal wear of wear parts
- Tools
- Drill bits
- Damage resulting from failure to observe the safety regulations
- Damage resulting from improper handling or use of the GRASS PRO1 for other than its intended use
- Damage to the material being drilled
- Loss of earnings due to a defective GRASS PRO1
- Assembly times, travel times, traveling expenses

5.0 Safety Instructions

- It is the obligation of the machine owner or his authorized representative to ensure that the operating personnel is instructed in the use of the machine.
- Work on the electrical equipment may only be carried out by qualified and authorized electricians.
- The connecting leads for compressed air and electricity must be correctly laid and protected against damage (e.g. in cable trenches or similar routings).
- During maintenance and repair work on the machine, the machine must always be disconnected from the main power supply (unplug the machine) and from the compressed air supply (e.g. at a quick-coupler).
- Before tool changing, gearbox changing, or during work in the area of the drill bits, always turn the main switch to the “0” position.
- Use only approved and correspondingly strong tools (e.g. from the Grass GmbH product range).
- Only carbide metal or HSS drill bits with an overall length of 57.5mm and a shank diameter of 10mm may be used.
- The drill bit diameter may be max. 35mm on the drive spindle unit and max. 10mm on all other spindles.
- Before starting work, always check all safety equipment for completeness and function.
- Replace damaged parts only with OEM parts.
- Work particularly carefully with large workpieces that extend beyond the boundaries of the machine.
- After finishing work, always disconnect the machine from the main power supply and secure it to prevent use by unauthorized persons.
- Always check that the main plug is removed before adjustment of the machine and before tool changing.
- Keep the place of work and the machine clean at all times; dirtiness and untidy places of work increase the risk of accidents.
- Protect yourself from electric shock.
- Use the machine only in dry rooms; do not leave the machine standing outdoors.
- Keep unauthorized persons away from the machine.
- The machine may only be operated by an authorized person.
- Keep your hands out of the working area of the drill bits and the insertion die arm during work.
- Wear appropriate work clothes when working with or on the machine; do not wear loose or wide clothing that could be caught up in moving parts of the machine.
- Ensure that long hair can not be caught up in moving parts of the machine.
- Wear safety goggles and a dust mask when working with or on the machine.

5.1 Residual Risks in Accordance with EN ISO 10200-1

The GRASS PRO1 is built to state-of-the-art and generally recognized safety rules and regulations. Risks to the life and limb of the operator or third parties, or impairments to the machine or other assets can nevertheless occur during use.

Residual risks exists:

- If the machine is operated by unqualified personnel
- If the machine is operated without the necessary guards
- If improper tools are used or if the tools are not correctly installed on the machine
- For the 2nd hand of the operator during drilling, insertion or clamping movements of machine parts
- If other persons are allowed to remain in the area of the operating machine
- In the event of interventions in a not correctly secured (switched off) machine
- In the event of failure to observe the prescribed working procedures
- In the event of a failure of control elements

These residual risks can be minimized if the safety instructions are observed.

Furthermore:

- During continuous series-production operation, a dust collector suction unit must be installed in accordance with the Workplace Ordinance.
- Adequate lighting must be ensured in accordance with the Workplace Ordinance.
- The machine may only be operated with functional safety guards.

5.2 Hazards and Safety Measures

Hazards and impairments to the life and limb of the operator or third parties, to the machine proper or to other assets or auxiliary materials may arise during the operation of the machine.

The manufacturer assumes no liability for such incidents!

A prerequisite for safe handling and trouble-free operation of this machine is the knowledge and understanding of the safety and operating instructions in this documentation.

Hazard	Safety measure
Release tool	➤ Chuck with clamping screw
Tool - breakage	➤ Use only branded products from the manufacturers product range ➤ Wear personal protective equipment
Tool - contact	➤ All tools behind transparent covers
Tool - machine contact	➤ Safety drilling depth stop
Workpiece flying out	➤ Workpiece stops, hold-down devices
Feed mechanisms	➤ No automatic feed movements
Workpiece clamping device	➤ Pictogram on the hold-down device (= insertion die arm)
Risk of collision	➤ None, as the lifting movement are slow
Drives	➤ Direct drives in completely enclosed gear housings
Tool unit	➤ Feed for lifting movement via buttons with collar without latching; ➤ Observance of the safety distances according to EN 294, depending on the risk
Controller, unexpected tool starting/unexpected lifting	➤ Electrical controller with P/E converter, Buttons with collar without latching
Controller, tool starting during insertion	➤ Monitoring of the insertion die arm with pneumatic valve
Electricity	➤ Equipment to EN 60204 Part 1, VDE 0100 or IEC 384
Noise	➤ Wear personal protective equipment

5.3 Safety Equipment

- Compressed air filter/pressure reducer against mechanical overloading of the machine, see Pneumatic circuit diagram chapter 10.1
- Thermal overload protection for the electric motor, see Electrical circuit diagram chapter 10.2
- Controllable non-return valve directly on the main cylinder prevents lowering of the machine in the event of a loss of compressed air pressure; the valve opens only when the Start button is pressed, see Pneumatic circuit diagram chapter 10.1
- The motor does not run during insertion
- Protection against contact with the drill bit (vertical)

5.4 Machine Warning Labels



Danger!



Risk of crushing

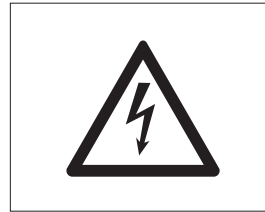

Hazardous Voltage

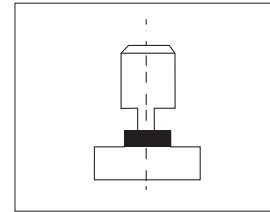

Valve for clamping cylinder

5.5 Purpose

The GRASS PRO1 is designed and engineered only for the operations described in chapter 1.3 Intended Use. The manufacturer guarantees the proper function of the machine for all these applications. Use for any other purpose may result in injury to the operating personnel or in damage to the machine or workpieces.

5.6 Identification of the Product

All machines bear a rating plate on which the year of manufacture, machine number, machine type, rated voltage and frequency and the necessary compressed air pressure can be found. A sticker with the machine designation can also be found on the motor bracket.

6.0 Standard Specification

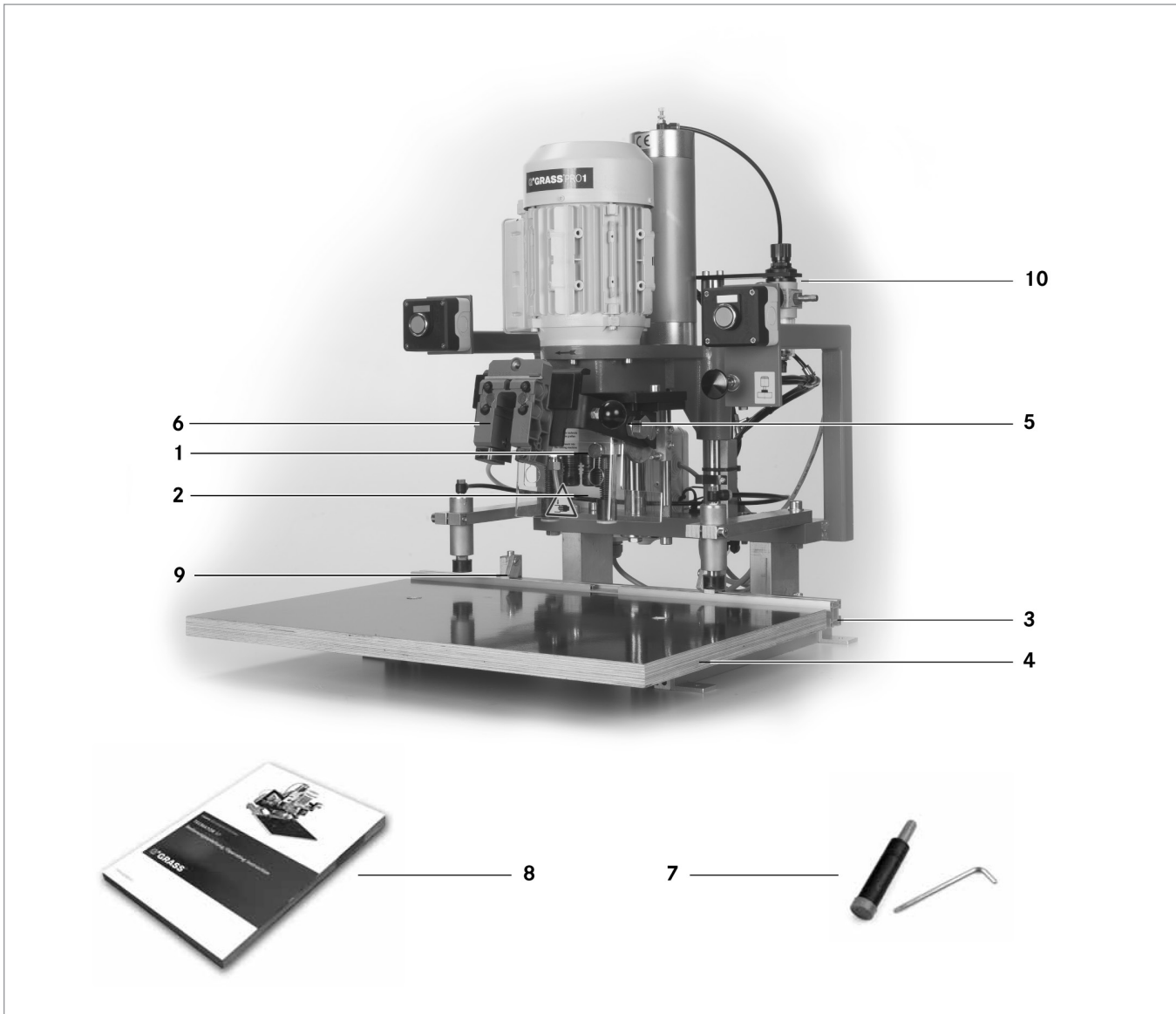

Standard Specification

1. 3-spindle drilling head with quick-change chucks
2. Drill bits for hinge drilling (1 x 35mm RH and 2 x 8mm LH diameter)
3. Combined stop and ruler, 600mm long
4. Wood supporting table, 600mm wide and 400mm deep
5. Insertion die arm to hold the insertion die
6. Insertion die for hinges
7. Allen keys, open-jaw wrenches, 10mm, 13mm, and 17mm
8. Operating manual
9. Side stop left and right
10. Air Regulator

7.0 Location of Main Components

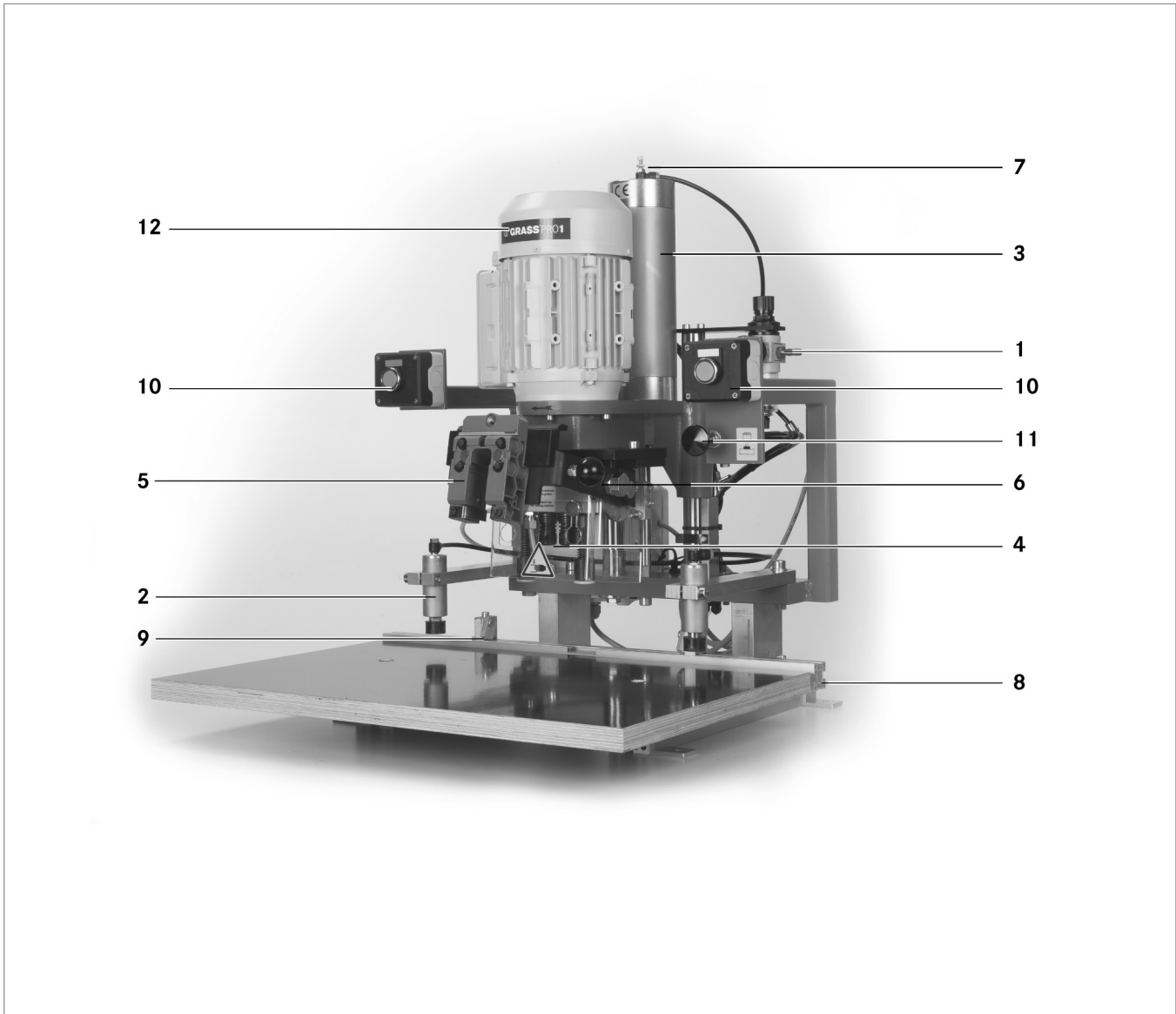

Main Components

1. Air hook-up
2. Hold-down devices
3. Lift cylinder
4. Safety shield
5. Insertion die
6. Swivel arm
7. Lift cylinder airflow switch
8. Combined stop and ruler
9. Side stop left and right
10. Start button, 2 hand control
11. Control valve for hold-down devices
12. Electric motor

8.0 Gearbox hole patterns GRASS PRO1

Depending on the version selected, the standard gearbox and the drill bits supplied can be used to drill the following hole patterns:

GRASS PRO1 Drilling Template

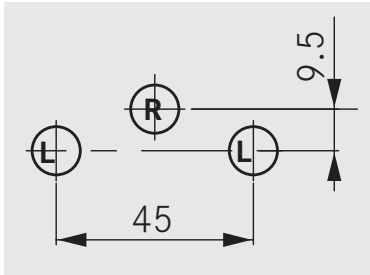

9.0 Description of the operating elements

Start buttons for the vertical lifting movement



Pressing the two buttons simultaneously starts the vertical drilling or insertion operation. Manipulation of the 2-hand control unit are dangerous and not permitted. Your hands must not be in the danger area of the drill bits, hold-down devices or insertion die when operating the 2-hand control unit. After a defined travel distance, the drill motor is started automatically. Both buttons must remain pressed until the drill has reached the end position (stop).

Releasing the buttons earlier causes the drilling head to move up again.

Selector switch for pneumatic hold-down devices



The hold-down devices can be controlled with the right-hand valve. Pulling the knob causes both hold-down devices to lower. To release the hold-down devices, press the knob in again. The hold-down devices must be adjusted to the workpiece height. The available stroke is limited to 5mm!

- Pulled position = Workpiece clamped
- Pressed position = Workpiece released

10.0 Circuit diagrams

10.1 Pneumatic Circuit Diagram

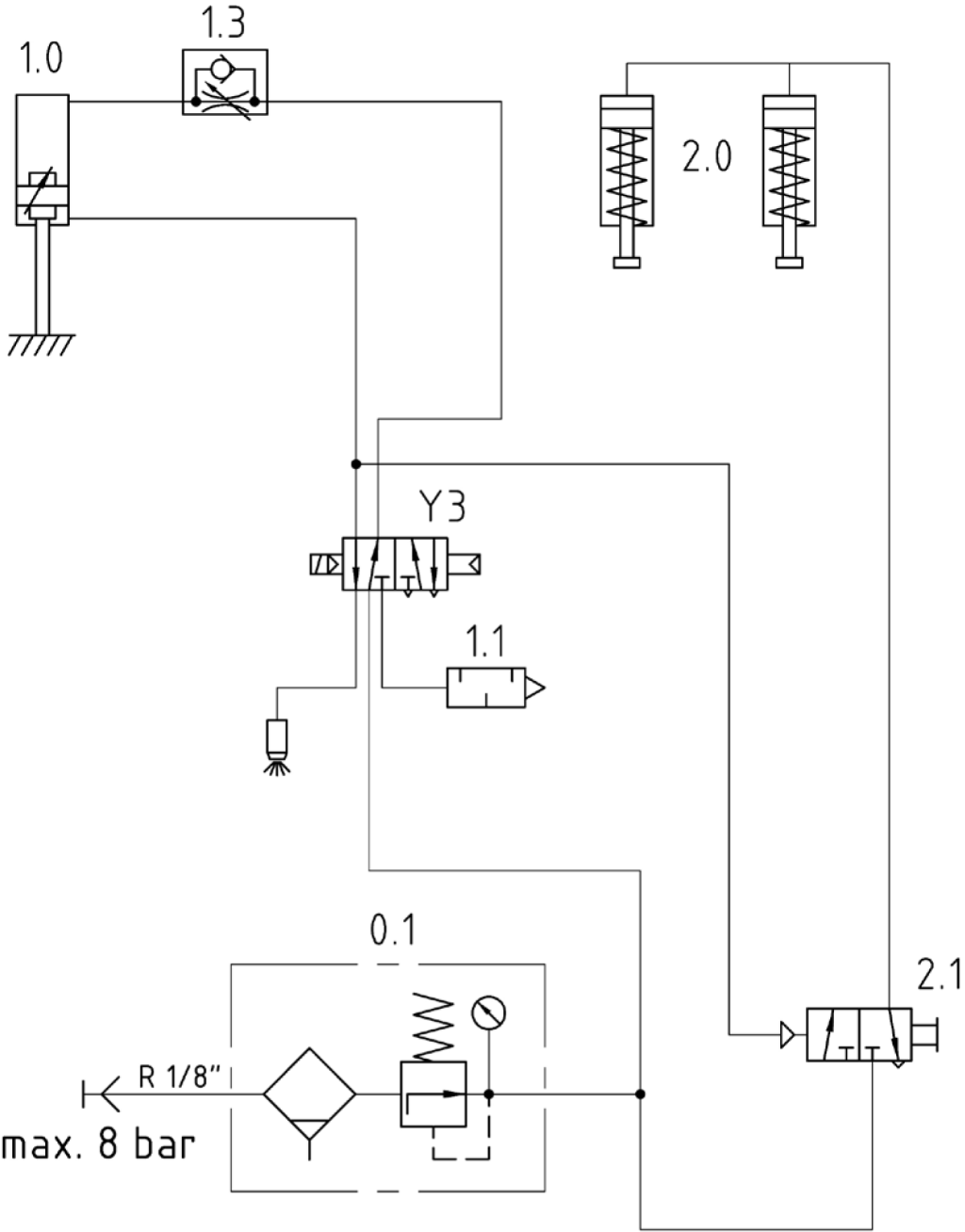

Operating Pressure: 6 bar

10.2 Electrical Circuit Diagram

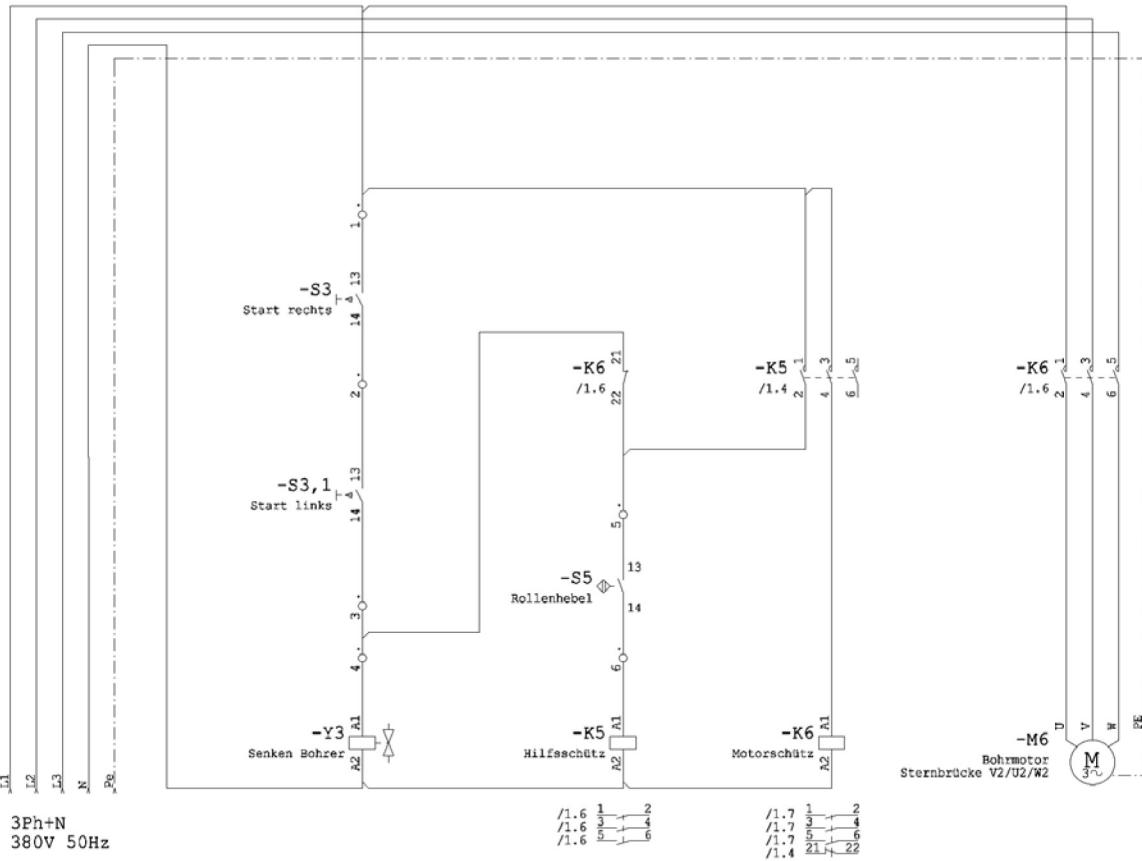
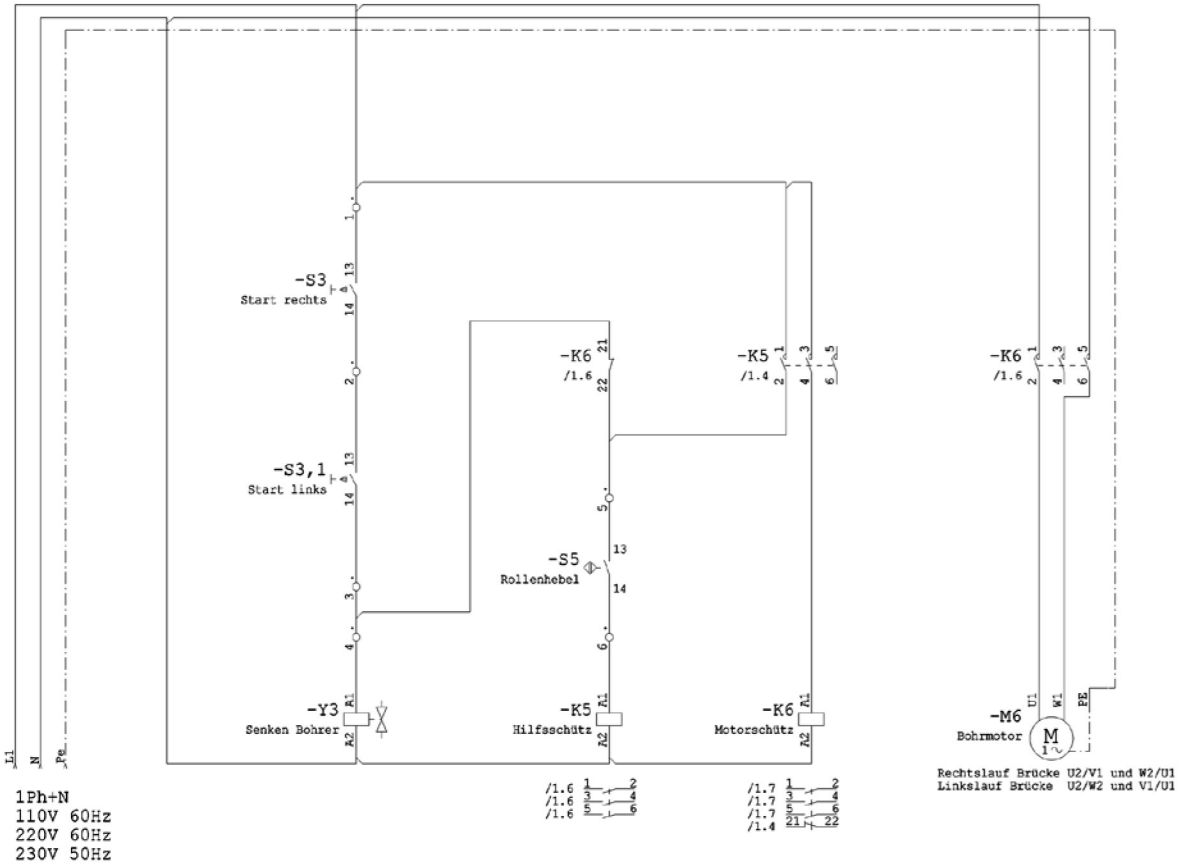

11.0 Transport, installation, and final adjustment

The GRASS PRO1 is delivered together with all the accessories. The machine must be installed in a stable position on a sufficiently large table surface (beyond the dimensions of the machine). Align the machine at its final installation location using a level.



Important!

The machine must not be lifted by the machine table (aluminum profiles); otherwise, the machine settings could be changed.

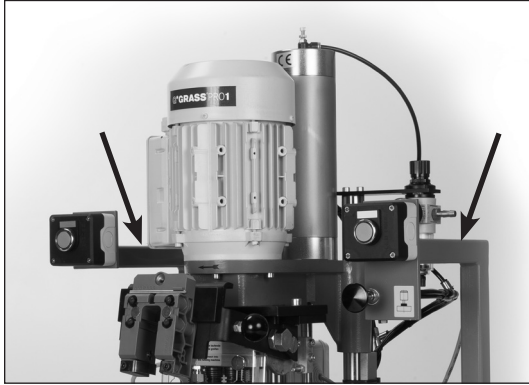

Carry the machine only at the strut

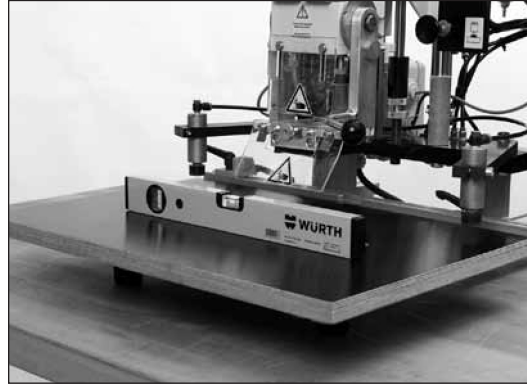

Align the machine using a level

11.1 Scope of Supply

- Inspect the machine after unpacking for possible damage.
- Report any damage discovered to the supplier immediately.
- Check the scope of supply immediately after unpacking. Simply compare the goods with the delivery note for correspondence.
- Report any missing parts discovered to the supplier immediately.

11.2 Transport and Storage Conditions

- Protect the machine against moisture and wetness during transport and storage.
- Storage temperature from -20°C to $+50^{\circ}\text{C}$.

11.3 Space Requirements and Surrounding Conditions

- The space required depends on the size of the workpieces to be handled.
- The minimum dimension for the depth is approx. 80 cm (31 1/2").
- The minimum dimension for the width is approx. 100 cm (39 3/8"), plus an additional 100 cm per extension ruler and side.
- The machine must be installed in a dry room where it is protected against moisture and wetness.
- The temperature during operation of the machine should lie in the range of $+10^{\circ}\text{C}$ to $+40^{\circ}\text{C}$.
- The relative humidity should lie in the range of 10% to 80% , non-condensing.
- Large deviations can lead to malfunctions in the operation of the machine.

12.0 Commissioning

12.1 Pneumatic Connection

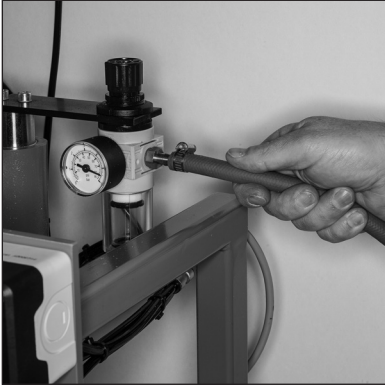

Connect a hose with an inside diameter of 8mm to the air regulator. The hose must be fitted with a shut-off valve or coupling at a maximum distance of 1.5 meters to the GRASS PRO1.

Recommended air pressure 6 bar, air consumption per stroke approx. 1.8 liters. The compressor should have a tank capacity of at least 100 liters and an intake capacity of 200 liters/min. If the machine is not connected to the compressed air grid by means of the coupler provided, a shut-off device must be installed near the operator.

12.2 Removal of the Drop Arrester

Before commissioning, remove the drop arrester at the guide.

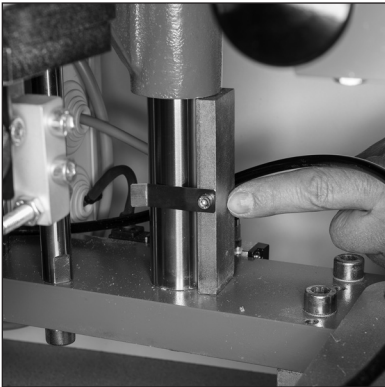

Important!

Compressed air must be connected before the drop arrester is removed.

12.3 Function Test

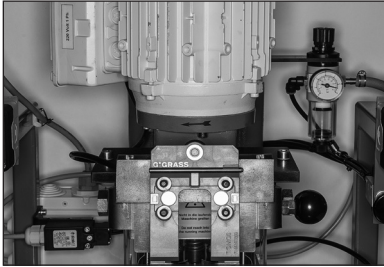

Connect the machine

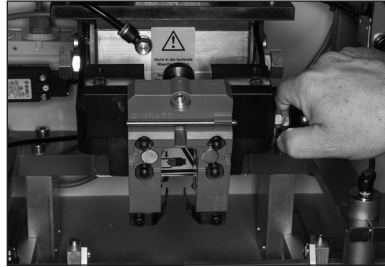

Push the insertion die arm up

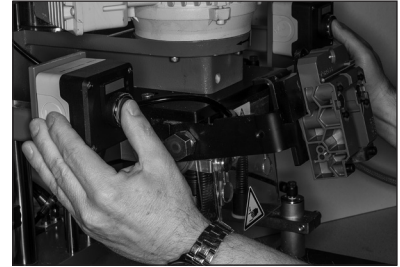

Press the Start buttons
(the motor bracket moves downwards)

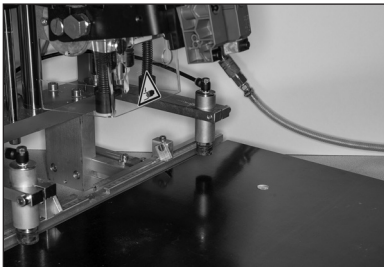

Release the Start buttons (the motor bracket moves back to its starting position)

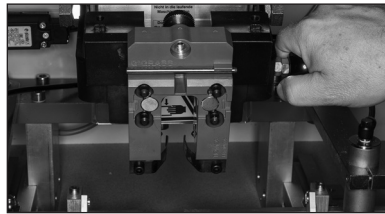

Push the insertion die arm down

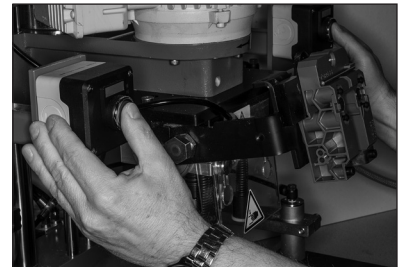

Press the Start buttons
(the motor bracket moves downwards)

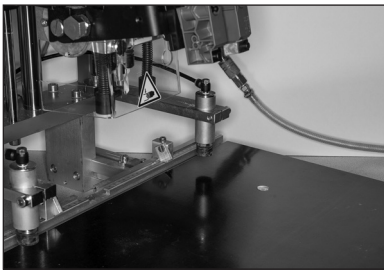

Release the Start buttons (the motor bracket moves back to its starting position)



Contact the manufacturer if the function test was not successful.

12.4 Electrical Connection

The electrical connection of the machine may only be made by authorized electricians in accordance with the national regulations. The machine is delivered without a plug. A plug will need to be ordered according to the correct voltage. The plug socket must be freely accessible, at a suitable working height and in the vicinity of the operator.



Attention:

The direction of rotation of the motor must correspond to the arrow on the drilling head.



Danger!

Danger from electric voltage. Disconnect the machine from the electrical power supply before starting any work on the electrical system.

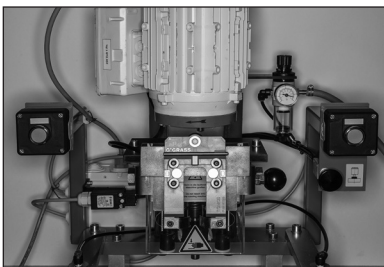

Connect the machine

13.0 Working with the GRASS PRO1

13.1 Requirements for the Operating Personnel

- This machine may only be operated by persons who are familiar with the handling of the machine.
- This knowledge can be gained through a thorough training by persons familiar with the handling of the machine, or by thoroughly studying this operating manual.
- The operating personnel must be capable of operating this machine.
- It is the responsibility of the machine owner to check whether the operating personnel is operating the machine in accordance with this operating manual.
- The owner of the machine is responsible for ensuring compliance with these instructions.

14.0 Set-up of the GRASS PRO1 for Hinges

14.1 Installing an Insertion Die (ID)

1

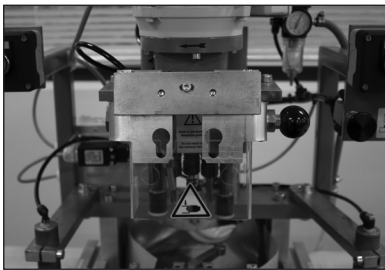

Push the insertion die arm up

2

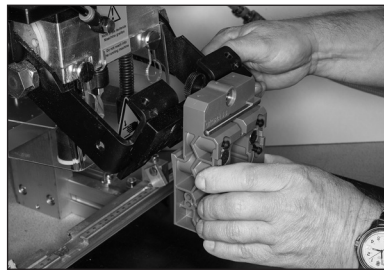

Angle ID to "hook" onto the ID arm

3



Fit ID onto bottom of ID arm

4



Fix ID in place by tightening clamp screw

14.2 Setting the Drilling Depth using the bits.

The machine is set at the factory to a drilling depth of 13mm, referred to a board thickness of 13mm.

Drill bits

In the original depth condition, the drill bits have a length of 57.5mm. If the length is reduced due to resharpening, this can be compensated at the adjustment screw.

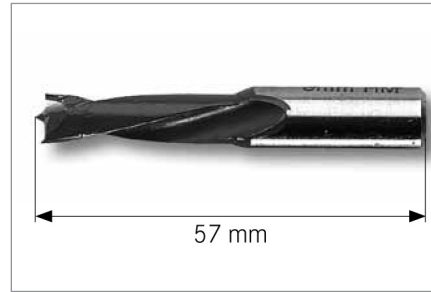
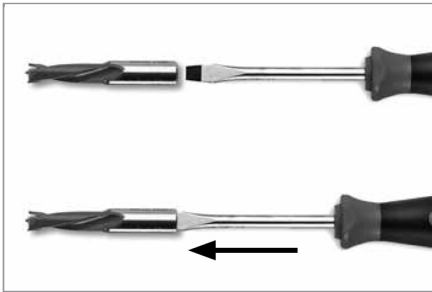

The length of the drill bit can be compensated at the adjusting screw. The length of the drill bit should be 57.5mm

14.3 Setting the drilling depth

1. Install drill bits for hinges (1 x 35mm RH / 2 x 8mm LH)
2. To set the depth stops follow these instructions. **NOTE: Do not hook up power until this adjustment is made.**

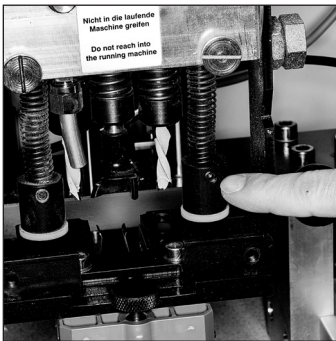

A. This screw adjusts for the cup drilling depth. Loosen set screw and it threads up or down.



B. You only need the air connected to use the pneumatics for this step. When you push in this button on this switch the cylinder will go down. (It is on the back of the machine.)

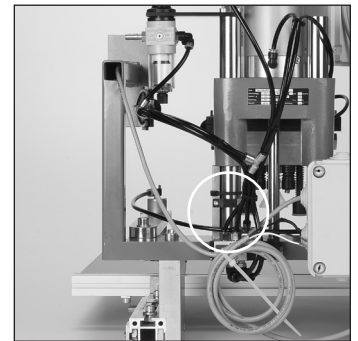

C. Make adjustments to both depth stops, separately.



Left side depth stop



Right side depth stop



Now both are the same.

D. Plug in power to the machine to test drill. Use the two hand start buttons on the front of the machine to operate the machine.

3. Loosen Allen Head bolts on the table fixing bracket. Set cup drilling location needed from the edge of the door to the edge of the 35mm cup hole. Example: 110mm or 11cm = 2.5 Tab
4. Adjust the door stop to the location needed to drill the center of your cup hole on the door.



Loosen bolt to fix fence location needed for drilling.

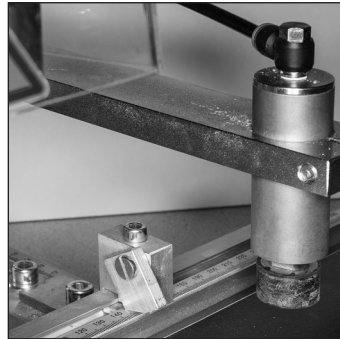

Set stops to locate cup hole drilling.

14.4 Setup for cup-hole location

5. Insert a wood panel and press against stop and ruler.
6. Adjust the hold-down devices and adjust the height to hold the wood panel.
7. Start the drilling operation with the two-hand control and release to stop the drilling operation.

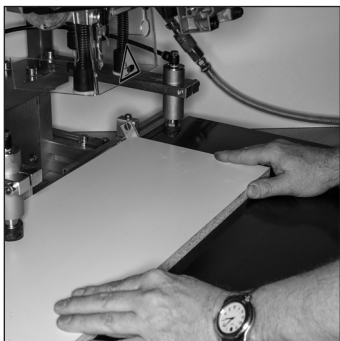

Press workpiece against the stop.



Clamp the hold-down devices.



Perform drilling operation.

8. Place the hinge into the die and swing the hand lever down over the drilled hole.

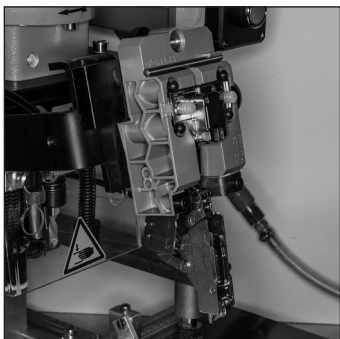

Insert hinge.



Press hand lever downwards.



Pull hand lever up then remove workpiece.

For adjustments see page 19

Adjustments



Hand lever adjusting screw.
(front to back)

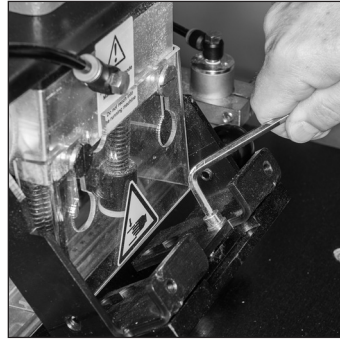

Front-to-back adjustment on ID
arm plate.



Side-to-side adjustment on ID
arm plate.

NOTE: If the hinge is not pressed completely flush into the cup hole, this can be due to the pressing angle of the hand lever or the insertion die mounting plate for the die. Both will allow the die to move front to back. An allen bolt on the mounting plate allows side-to-side movement.

14.5 Adjustment of the Side Stops

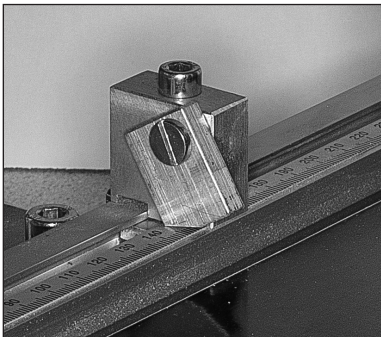

The combined stop and ruler is adjusted at the factory to 0 relative to the center of the main spindle so that the stops can be adjusted exactly using the millimeter or inch scale. First loosen the clamping allen bolt, then tighten again after adjustment.

14.6 Adjustment of the Hold-down Devices

The hold-down device is suitable for a wide range of material thicknesses and can be used on both left and right hand sides of the machine.

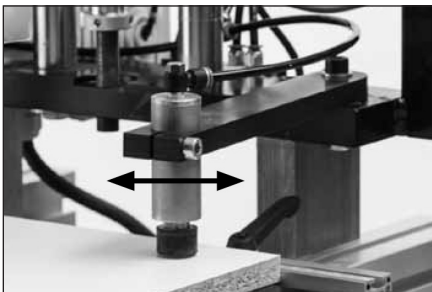

Move the hold-down device to the desired position.



Loosen the hold-down devices at the clamping screw.

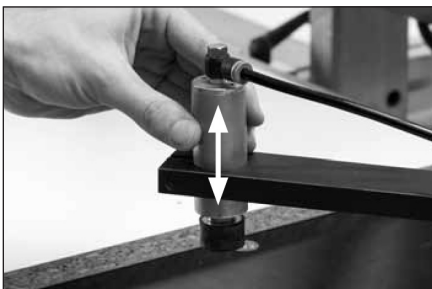

Adjust the height of the hold-down devices and tighten the clamping screw again.

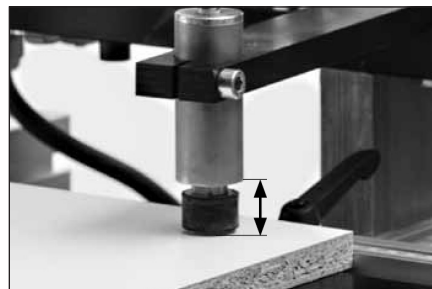

Attention: The available stroke is limited to 5mm!

15.0 Operation of GRASS PRO1 for Drawer Assembly

Note: The same process is used for the assembly of both the ZBox and Zargen drawer systems.

15.1 Assembly of Zargen & ZBox with PRO1

To assemble, drill drawer back dowel holes for each side by positioning back against the side-to-side stop.

To ensure correct positioning of the drawer front dowel holes, place drilled drawer back against right side of 13mm stop. Set floating side stop at opposite end of panel. Drill bits are countersunk to allow for easy installation of dowels.

To drill right side of drawer front, place front against the 13mm stop. To drill left side, place front against floating side stop.



15.2 Assembly of Zargen & ZBox with ZRam

To insert the slide, position the slide against the ZRam arm and place drawer back over the dowel. Repeat for other side.

Place drawer front face down on ZRam. Position slide over dowel holes and depress foot pedal. Repeat for other side.

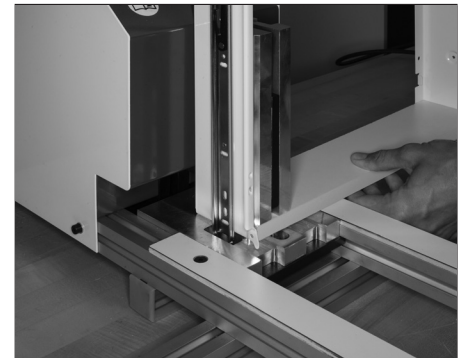

After assembly is complete, place drawer box on a stable surface and press bottom firmly over tabs.

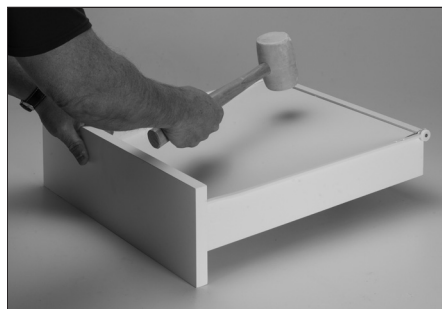

Final Assembly of Zargen

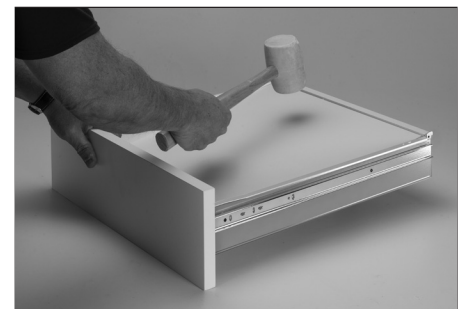

Final Assembly of ZBox

16.0 PRO1 Machine Options and Accessories

16.1 for Hinge Drilling

Grass PRO1 for Hinge Drilling

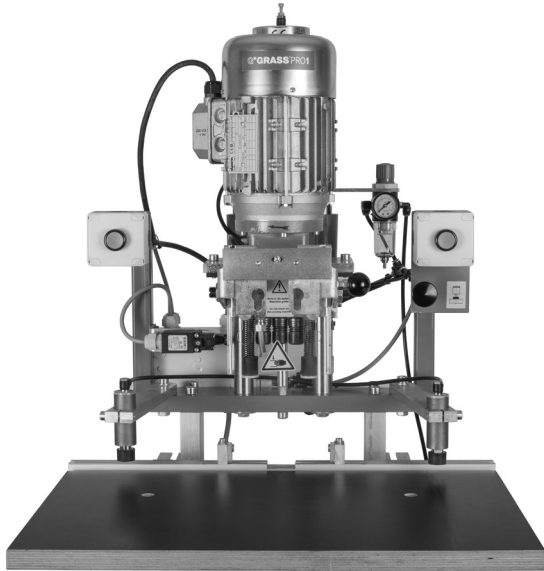

- Depth stop can be adjusted to material thickness
- Functional design
- Easy, fast and efficient operation
- Easy maintenance
- 45mm boring pattern

Description	Item No.	PU
220v single phase pneumatic	94559-01	1
220v three phase pneumatic	94560-01	1
110v single phase pneumatic	94561-01	1



Description	Item No.	PU
Extension fence 300mm to 1550mm	88612-01	1

Drill Bits

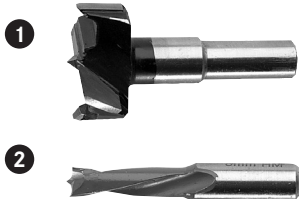

Description	Direction	Item No.	PU
1 35mm bit	RH	00077-01	1
2 8mm bit	LH	00160-01	1
American Bit Set for Hinge Drilling		00213-01	1

Set consists of:

- 1 - 35mm bit, RH
- 2 - 8mm bit, LH

Fence Stops

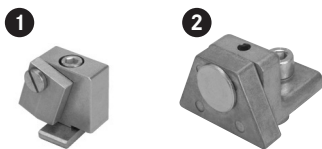

Description	Item No.	PU
1 Additional fence stop	949.200.21.0000	1
2 Additional fence stop, large	949.200.21.0100	1

Insertion Dies

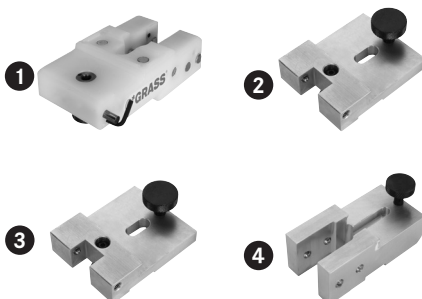

Description	Item No.	PU
1 Tiomos Universal Insertion Die 110°/120°/160°	80039	1
2 TEC Die for all cup styles	92617	1
3 Nexis 110°/125°	04216-01	1
4 Nexis 170°	04218-01	1

16.2 For Drawer Assembly

Grass PRO1 for Zargen and ZBox

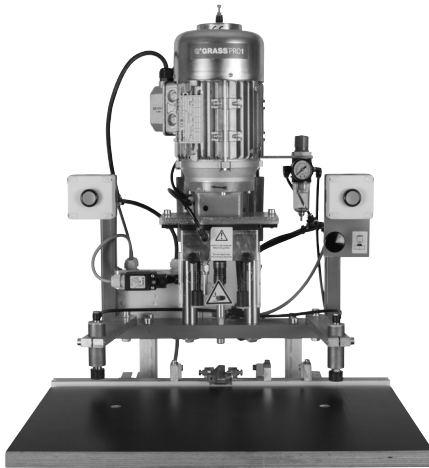

- Depth stop can be adjusted to material thickness
- Functional design
- Easy, fast and efficient operation
- Easy maintenance
- 3 spindle gear box

Description	Item No.	PU
220v single phase pneumatic	80131	1
220v three phase pneumatic	80132	1
110v single phase pneumatic	80068	1

Note: Machine Item Numbers above include the three items in PRO1 Kit #801542

Zargen and ZBox Conversion Kit

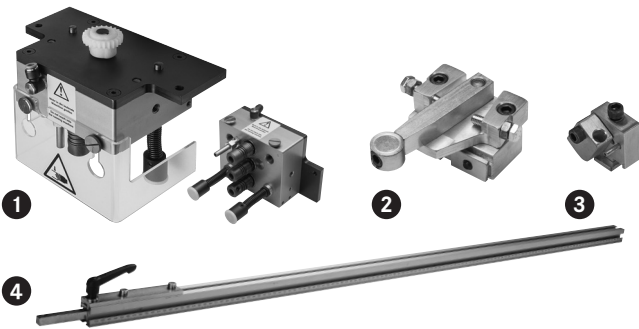

Description	Item No.	PU
1 PRO1 Gear box	80151	1
2 PRO1 Side-to-side Stop	80153	1
3 PRO1 13mm Fence Stop	80152	1
PRO1 Kit (gear box, fence stop and side stops)	80154	1
4 Extension fence 300mm to 1550mm	88612-01	1

Bits

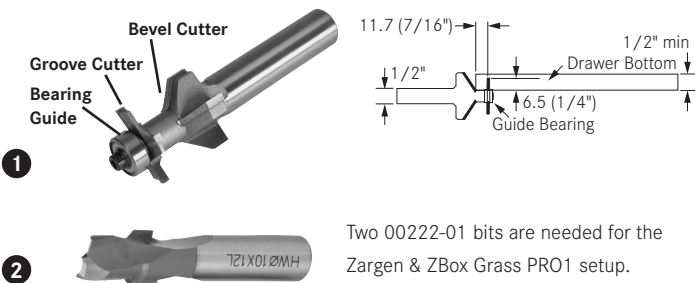

This bit is designed for grooving and beveling the drawer bottoms for the lipped version of the ZBox and Zargen drawer slide. The bit comes only with a 1/2" shank.

Description	Item No.	PU
1 Router bit	00197-01	1
2 10mm Carbide counter sink drill bit, LH	00222-01	1

ZRam for Zargen and ZBox



- Designed for semi-automated assembly of ZBox and Zargen slides
- Operated by a foot pedal – air required
- No adjustment required when using various heights or when switching slide types
- Economical solution for drawer assembly

Description	Item No.	PU
ZRam	93250-01	1
ZRam Retrofit Kit	69401	1

PU - Packaging unit

16.3 For Vionaro Assembly

Grass PRO1 for Vionaro

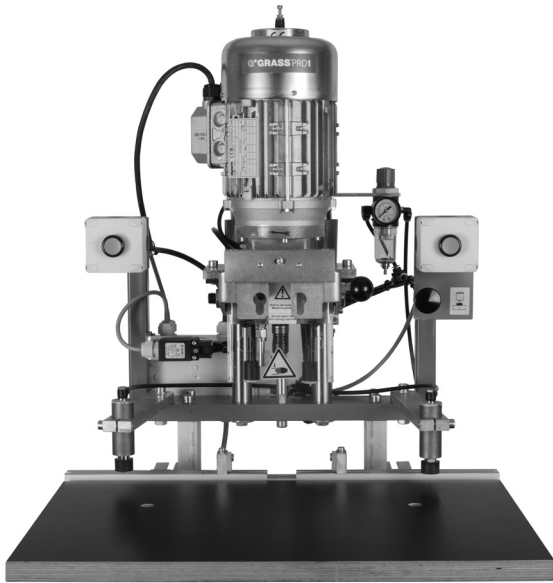

- Depth stop can be adjusted to material thickness
- Functional design
- Easy, fast and efficient operation
- Easy maintenance
- 3 spindle gear box

Description	Item No.	PU
220v single phase pneumatic	80063	1
220v three phase pneumatic	80064	1
110v single phase pneumatic	80065	1



Description	Item No.	PU
Extension fence 300mm to 1550mm	88612-01	1

Drill Bits

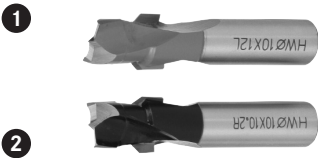

Description	Direction	Item No.	PU
1 10mm Carbide counter sink bit	LH	00222-01	1
2 10mm Carbide counter sink bit	RH	00229-01	1

Insertion Die



Description	Item No.	PU
Vionaro insertion die	30683-01	1



GRASS America Inc.
1202 NC Highway 66 South
Kernersville, NC 27284

Phone: 1-800-334-3512
Fax: 1-800-525-8406

www.grassusa.com
info@grassusa.com

